

Article number: 2310431007

Description: E+G Levelling elements  
LX.25-SW13-M6X62

## Measures

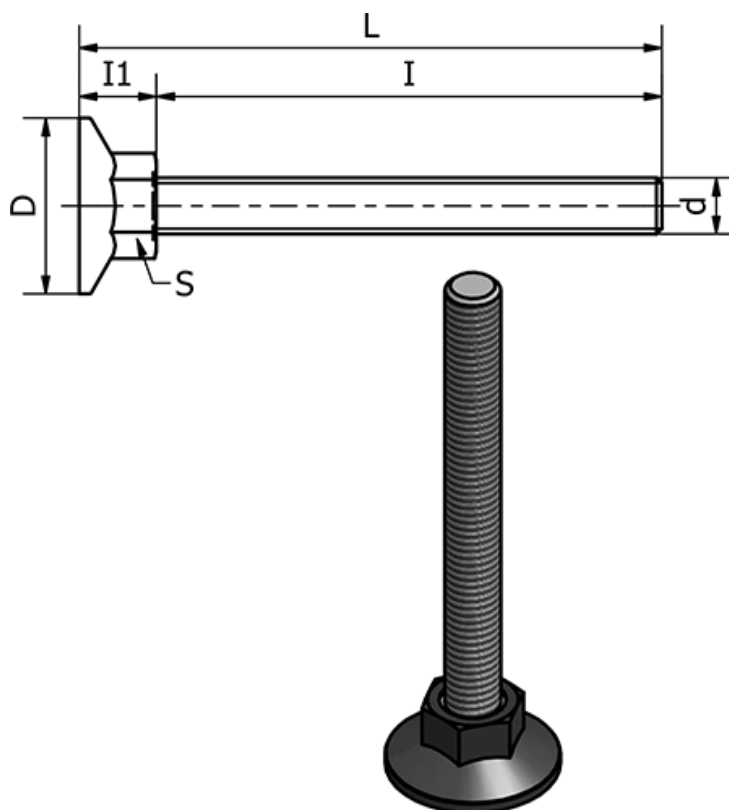

d	= M6
D	= 25
I	= 62
I1	= 11
L	= 73
S	= 13
Static load in (N)	= 1500
Type	= Forzinket

Weight (g) = -